

MPVC-4B-KVFDA

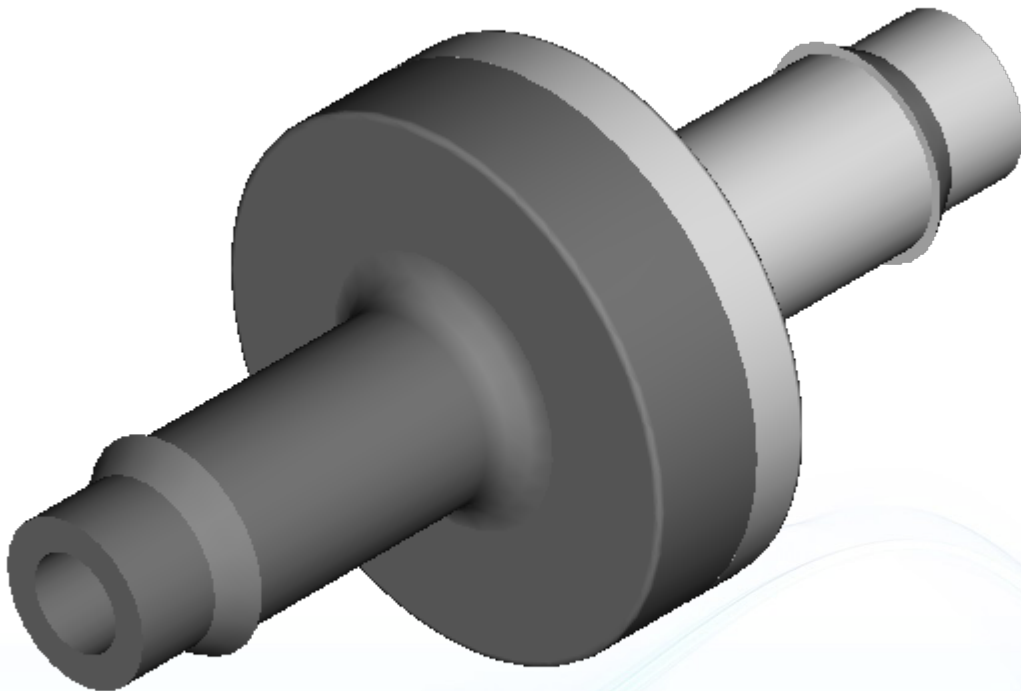



Pneuline
Supply, Inc.

DATA SHEET

MPVC-4B-KVFDA

Product Series:	MPVC
Product Type:	Inline Check Valve Cleanroom
Housing Material:	Kynar
Diaphragm Material:	0.030" FDA Viton
Inlet:	Natrual Kynar 720
Outlet:	Grey Kynar 720
Max Operating Temp:	250.00°F / 121.11°C
Min Operating Temp:	-40.00°F / -40.00°C
Product SKU:	001020005

Physical Properties

Size and Weight:	1.530 Long 0.750 Wide, 4.42g
Max Operating Tensile Stress:	20 lbs
Max Allowable Leak Rate:	0.009 cm ³ /sec @ 65 psi (air)
Max Operating Pressure:	65 psi (air)
Cracking Pressure:	0.0 psi (Normally Open)
Required Sealing Back Pressure:	Less than 0.1 psi (air)



Pneuline
Supply, Inc.

DATA SHEET

MPVC-4B-KVFDA

Flow Rate (Gpm) vs. Test Pressure (Psi)

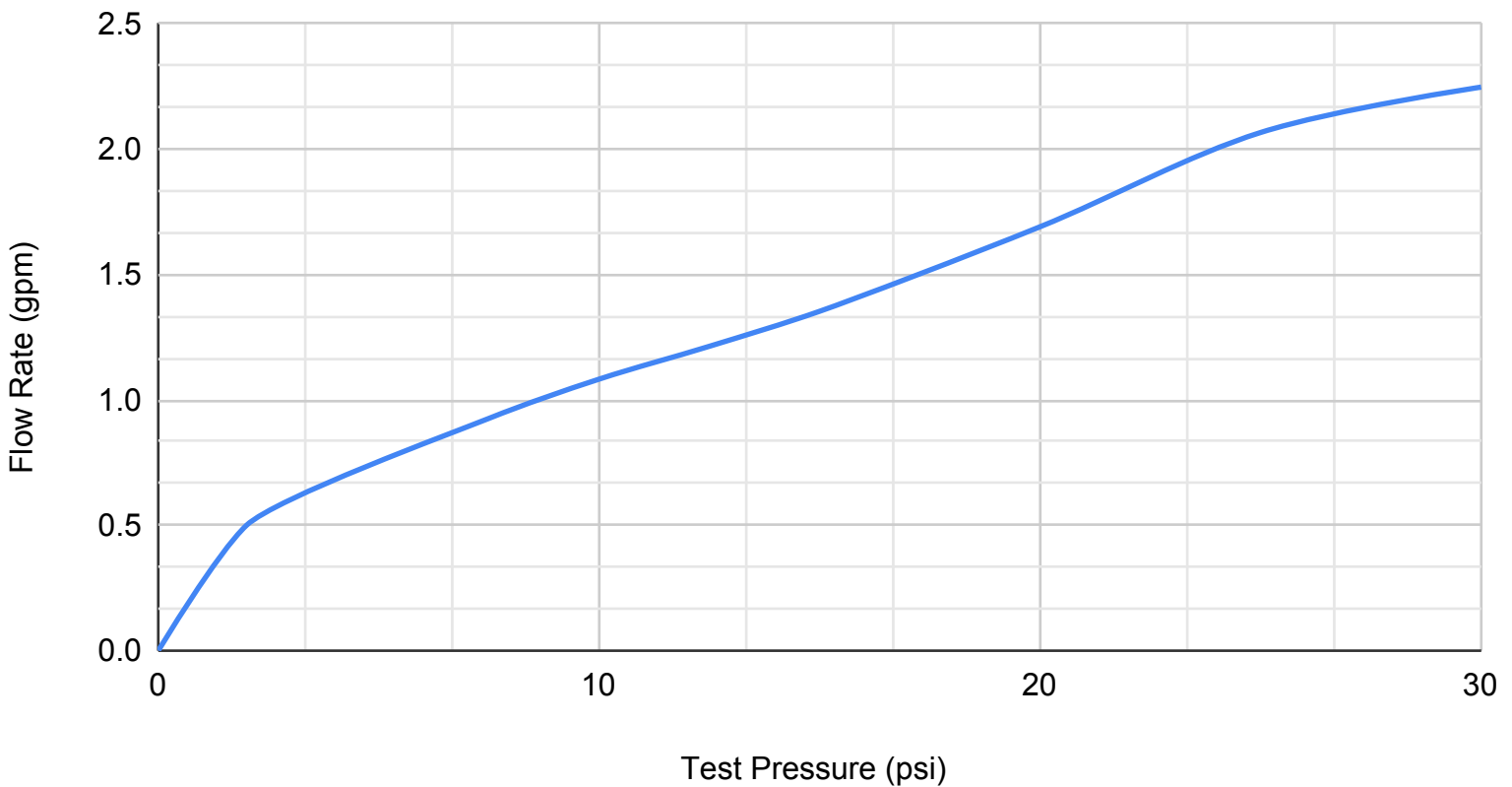

MPVC-4B-KVFDA

Chemical Compatibility Information

Inline diaphragm type check valves, all types of filters, self-sealing check valves, ball type check valves, and spring loaded check valves are all products that can, and typically do, contain multiple types of different materials. The chemical compatibility of the whole product is limited to those chemicals which are compatible with all of the materials present in the product. Pneuline has compiled an extensive list of various chemical compatibility ratings for the different materials that we use to manufacture our products, and have provided a list of chemical compatibility ratings for each specific product based on the materials used in that product.

The rating system is as follows:

- **A = Excellent** -- *The product is fully compatible with the chemical and is recommended for continuous use within the normal operating parameters of the product (temperature, pressure, etc).*
- **B = Adequate** -- *The chemical causes a minor effect to the product, slight corrosion or discoloration, minor loss in performance or slightly shortened operating lifespan.*
- **C = Not Ideal** -- *The chemical has a pronounced effect on the product and will degrade it. Material softening, swelling, loss of strength, corrosion, and discoloration may occur. Use only for limited timespans and replace often.*
- **D = Severe Effect** -- *The chemical has a severe adverse affect on the product and will likely destroy it. Not recommended for use.*
- **N/A = No Data Available** -- *One or more of the materials in the product has an unknown compatibility with the chemical.*



MPVC-4B-KVFDA

Chemical Substance	Rating	Chemical Substance	Rating
Acetaldehyde	D	Barium Carbonate	C
Acetamide	C	Barium Chloride	A
Acetic Acid	A	Barium Hydroxide	A
Acetic Acid 20%	A	Barium Nitrate	C
Acetic Acid 80%	B	Barium Sulfate	A
Acetic Acid, Glacial	B	Beer	A
Acetic Anhydride	D	Benzaldehyde	D
Acetone	D	Benzene	A
Acetyl Chloride (dry)	A	Benzoic Acid	A
Acetylene	A	Benzol	A
Alcohols: Amyl	B	Bromine	A
Alcohols: Butyl	A	Butadiene	A
Alcohols: Ethyl	C	Butane	A
Alcohols: Isopropyl	A	Butanol (Butyl Alcohol)	A
Alcohols: Methyl	D	Buttermilk	A
Aluminum Chloride 20%	A	Butyl Amine	D
Aluminum Hydroxide	B	Butyl acetate	D
Aluminum Nitrate	A	Butyric Acid	B
Aluminum Potassium Sulfate 10%	C	Calcium Bisulfite	B
Aluminum Potassium Sulfate 100%	C	Calcium Carbonate	A
Aluminum Sulfate	A	Calcium Hydroxide	A
Amines	D	Calcium Hypochlorite	A
Ammonia 10%	D	Calcium Nitrate	A
Ammonia, anhydrous	D	Calcium Sulfate	C
Ammonia, liquid	D	Carbolic Acid (Phenol)	A
Ammonium Chloride	A	Carbon Disulfide	C
Ammonium Hydroxide	C	Carbon Tetrachloride	A
Ammonium Phosphate, Dibasic	D	Carbonic Acid	A
Ammonium Sulfate	D	Chlorine (dry)	A
Amyl Acetate	D	Chlorine Water	B
Amyl Alcohol	B	Chlorine, Anhydrous Liquid	N/A
Aniline	C	Chloroacetic Acid	D
Aqua Regia (80% HCl, 20% HNO ₃)	B	Chlorobenzene (Mono)	A
Arsenic Acid	A	Chloroform	A
Asphalt	A	Chlorosulfonic Acid	D

The information in this chart has been compiled from several sources and as such Pneuline makes no guarantee as to the accuracy or completeness of the information. This chart is ONLY to be used as a guide in selecting the appropriate product for a particular use case. A product's resistance to chemical exposure will vary based on a variety of factors including: temperature, exposure time, quantity, concentration, and purity of chemicals, presence or absence of catalyzing agents, and pressure. Ratings listed in this chart apply for a limited exposure time (normally 48 hours) and as such Pneuline offers NO warranty (express or implied) that a particular product will perform adequately in a given environment.

MPVC-4B-KVFDA

Chemical Substance	Rating	Chemical Substance	Rating
Chocolate Syrup	A	Ferric Sulfate	A
Chromic Acid 10%	A	Ferrous Chloride	N/A
Chromic Acid 30%	A	Ferrous Sulfate	C
Chromic Acid 5%	A	Fluorine	B
Chromic Acid 50%	A	Fluorosilicic Acid	B
Chromic Acid 80%	B	Formaldehyde 100%	D
Cider	A	Formaldehyde 40%	D
Citric Acid	A	Formic Acid	D
Copper Cyanide	A	Fuel Oils	B
Copper Nitrate	A	Furfural (Furfuraldehyde)	D
Copper Sulfate (more than 5%)	A	Gasoline (high-aromatic)	A
Copper Sulfate 5%	A	Gasoline, leaded, ref.	A
Cresols	B	Gasoline, unleaded	A
Cresylic Acid	B	Glucose	A
Cyclohexane	A	Glycerin	A
Cyclohexanone	D	Heptane	A
Detergents	A	Hexane	A
Dichloroethane	A	Honey	A
Diesel Fuel	A	Hydrochloric Acid 100%	A
Diethylamine	D	Hydrochloric Acid 20%	A
Diethylene Glycol	A	Hydrochloric Acid 37%	A
Dimethyl Aniline	A	Hydrofluoric Acid 100%	C
Dimethyl Formamide	D	Hydrofluoric Acid 20%	C
Epsom Salts (Magnesium Sulfate)	A	Hydrofluoric Acid 50%	C
Ethanol	C	Hydrofluoric Acid 75%	C
Ethyl Acetate	D	Hydrogen Peroxide 10%	A
Ethyl Chloride	A	Hydrogen Peroxide 100%	A
Ethylene Chloride	B	Hydrogen Peroxide 30%	A
Ethylene Chlorohydrin	A	Hydrogen Peroxide 50%	A
Ethylene Dichloride	A	Hydrogen Sulfide (aqua)	D
Ethylene Glycol	A	Isopropyl Acetate	D
Ethylene Oxide	D	Isopropyl Ether	D
Fatty Acids	A	Jet Fuel (JP3, JP4, JP5)	B
Ferric Chloride	A	Kerosene	A
Ferric Nitrate	A	Ketones	D

The information in this chart has been compiled from several sources and as such Pneuline makes no guarantee as to the accuracy or completeness of the information. This chart is ONLY to be used as a guide in selecting the appropriate product for a particular use case. A product's resistance to chemical exposure will vary based on a variety of factors including: temperature, exposure time, quantity, concentration, and purity of chemicals, presence or absence of catalyzing agents, and pressure. Ratings listed in this chart apply for a limited exposure time (normally 48 hours) and as such Pneuline offers NO warranty (express or implied) that a particular product will perform adequately in a given environment.



MPVC-4B-KVFDA

Chemical Substance	Rating	Chemical Substance	Rating
Lacquer Thinners	D	Nitrobenzene	B
Lacquers	D	Nitromethane	D
Lactic Acid	B	Oils: Citric	A
Lard	A	Oils: Fuel Oil (1, 2, 3, 5A, 5B, 6)	B
Lead Sulfamate	A	Oils: Mineral	A
Lubricants	A	Oils: Olive	A
Lye: Ca(OH) ₂ Calcium Hydroxide	A	Oils: Pine	A
Lye: KOH Potassium Hydroxide	D	Ozone	A
Lye: NaOH Sodium Hydroxide	C	Paraffin	A
Magnesium Chloride	A	Pentane	A
Magnesium Hydroxide	A	Perchloroethylene	A
Magnesium Nitrate	A	Phenol (10%)	A
Magnesium Sulfate (Epsom Salts)	A	Phenol (Carbolic Acid)	A
Mercuric Chloride (dilute)	A	Phosphoric Acid (more than 40%)	A
Mercury	A	Phosphoric Acid (crude)	A
Methanol (Methyl Alcohol)	D	Phosphoric Acid (less than 40%)	A
Methyl Acetate	D	Photographic Solutions	B
Methyl Alcohol 10%	D	Picric Acid	A
Methyl Butyl Ketone	D	Potassium Bromide	C
Methyl Cellosolve	D	Potassium Chlorate	C
Methyl Chloride	A	Potassium Chloride	A
Methyl Ethyl Ketone	D	Potassium Dichromate	A
Methylene Chloride	B	Potassium Hydroxide (Caustic Potash)	D
Milk	A	Potassium Nitrate	A
Mineral Spirits	A	Potassium Permanganate	C
Motor oil	B	Potassium Sulfate	A
Mustard	B	Propane (liquefied)	A
Naphtha	A	Propylene Glycol	C
Nickel Chloride	A	Pyridine	D
Nickel Nitrate	C	Salicylic Acid	A
Nickel Sulfate	A	Sea Water	A
Nitric Acid (20%)	A	Silicone	A
Nitric Acid (50%)	C	Silver Nitrate	A
Nitric Acid (5-10%)	A	Soap Solutions	A
Nitric Acid (Concentrated)	D	Soda Ash (see Sodium Carbonate)	A

The information in this chart has been compiled from several sources and as such Pneuline makes no guarantee as to the accuracy or completeness of the information. This chart is ONLY to be used as a guide in selecting the appropriate product for a particular use case. A product's resistance to chemical exposure will vary based on a variety of factors including: temperature, exposure time, quantity, concentration, and purity of chemicals, presence or absence of catalyzing agents, and pressure. Ratings listed in this chart apply for a limited exposure time (normally 48 hours) and as such Pneuline offers NO warranty (express or implied) that a particular product will perform adequately in a given environment.

MPVC-4B-KVFDA

Chemical Substance	Rating	Chemical Substance	Rating
Sodium Acetate	D	Xylene	A
Sodium Bicarbonate	A	Zinc Chloride	A
Sodium Bisulfate	A	Zinc Sulfate	A
Sodium Bisulfite	A		
Sodium Carbonate	A		
Sodium Chlorate	C		
Sodium Chloride	A		
Sodium Hydroxide (20%)	B		
Sodium Hydroxide (50%)	C		
Sodium Hydroxide (80%)	D		
Sodium Hypochlorite (less than 20%)	A		
Sodium Peroxide	A		
Sodium Sulfate	A		
Sodium Sulfide	A		
Sodium Thiosulfate (hypo)	A		
Stannic Chloride	A		
Stearic Acid	N/A		
Stoddard Solvent	A		
Sulfur Dioxide (dry)	D		
Sulfuric Acid (less than 10%)	A		
Sulfuric Acid (10-75%)	C		
Tannic Acid	B		
Tetrachloroethylene	A		
Tetrahydrofuran	D		
Toluene (Toluol)	A		
Tomato Juice	B		
Trichloroethane	B		
Turpentine	A		
Urea	A		
Vinegar	C		
Water, Acid, Mine	B		
Water, Distilled	B		
Water, Fresh	A		
Water, Salt	A		
Whiskey and Wines	A		

The information in this chart has been compiled from several sources and as such Pneuline makes no guarantee as to the accuracy or completeness of the information. This chart is ONLY to be used as a guide in selecting the appropriate product for a particular use case. A product's resistance to chemical exposure will vary based on a variety of factors including: temperature, exposure time, quantity, concentration, and purity of chemicals, presence or absence of catalyzing agents, and pressure. Ratings listed in this chart apply for a limited exposure time (normally 48 hours) and as such Pneuline offers NO warranty (express or implied) that a particular product will perform adequately in a given environment.



MPVC-4B-KVFDA

Chemical Compatibility Disclaimer

The information in this chart has been compiled from several sources (listed below) and as such Pneuline makes no guarantee as to the accuracy or completeness of the information. This chart is ONLY to be used as a guide in selecting the appropriate product for a particular use case. A product's resistance to chemical exposure will vary based on a variety of factors including: temperature, exposure time, quantity, concentration, the purity of the chemicals involved, presence or absence of catalyzing agents, and pressure. Ratings listed in this chart apply for a limited exposure time (normally 48 hours) and as such Pneuline offers NO warranty (express or implied) that a particular product will perform adequately in a given environment.

Sources

- <https://www.plasticsintl.com/chemical-resistance-chart>
- https://www.astisensor.com/KYNAR_PVDF_Chemical_Compatibility_Resistance_Chart.pdf
- <https://www.ipexna.com/media/12311/chemical-guide-us-ipex-pvdf.pdf>
- <https://www.polyfluor.nl/en/chemical-resistance/pvdf/>
- <https://www.fhr.com/KochFHR/media/Polypropylenes-unrestricted/PP%20Random%20Copolymers/P5M6K-080.pdf>
- <https://mykin.com/rubber-chemical-resistance-chart>
- <https://www.calpaclab.com/nylon-chemical-compatibility-chart/>
- <https://www.calpaclab.com/acetel-polyoxymethylene-chemical-compatibility-chart/>
- <https://www.calpaclab.com/polycarbonate-chemical-compatibility-chart/>
- <https://www.polyfluor.nl/en/chemical-resistance/pvdf/>
- <https://www.calpaclab.com/polypropylene-chemical-compatibility-chart/>
- <https://www.ipexna.com/media/11974/chemical-guide-us-epdm-fkm.pdf>

FOR REFERENCE ONLY

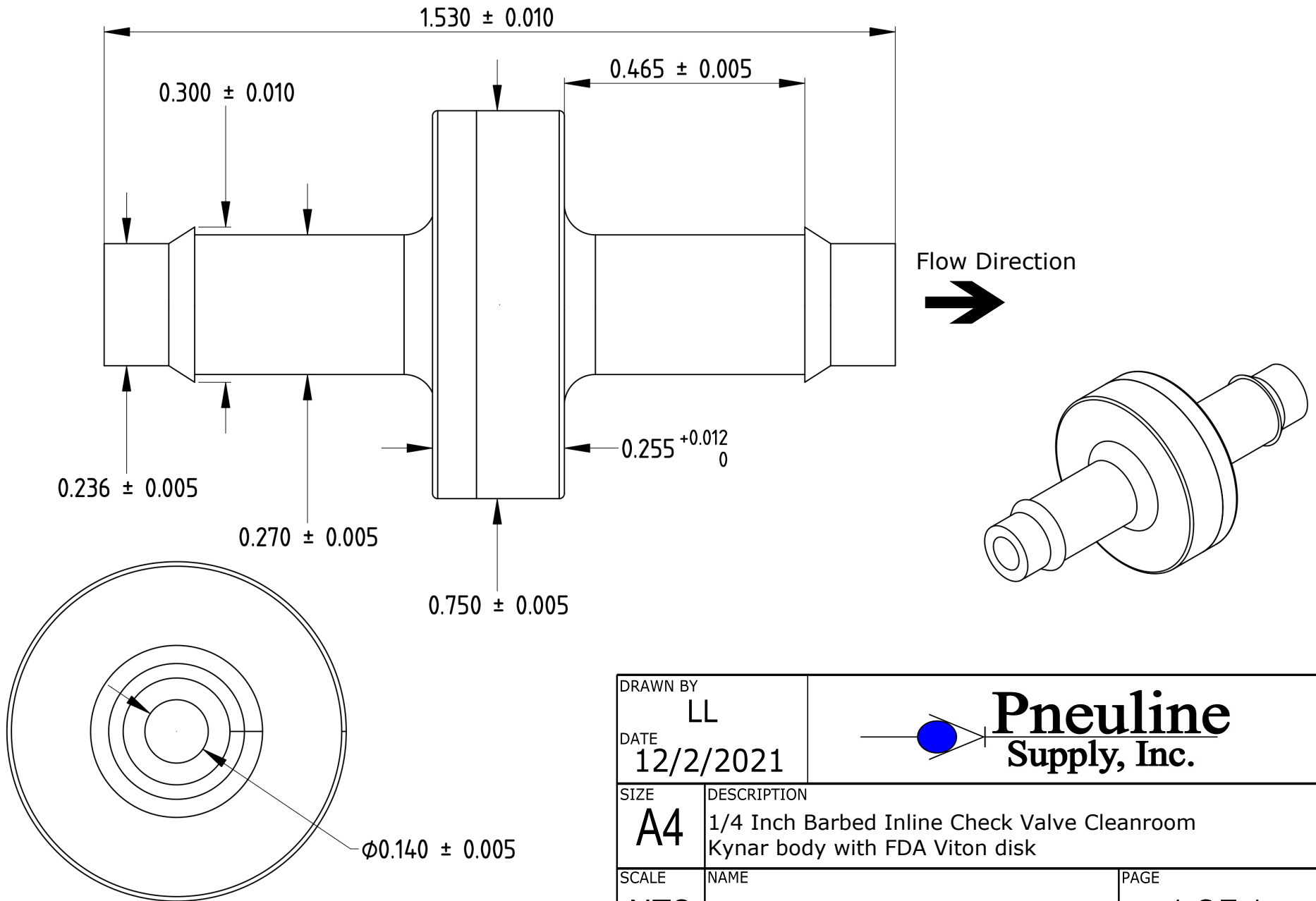

DRAWN BY LL		
DATE 12/2/2021		
SIZE A4	DESCRIPTION 1/4 Inch Barbed Inline Check Valve Cleanroom Kynar body with FDA Viton disk	
SCALE NTS	NAME MPVC-4B-KVFDA	PAGE 1 OF 1
This drawing is our property; it can't be reproduced or communicated without our written consent.		